



Power Meters

For single-phase, split-phase & 3-phase mains networks

Advanced Panel Meter (APM) Models P1 and P3

Programmable dynamic backlight colour



Warning flash



Universal, configurable & flexible

1% Accuracy

20 segment curved bar graph display

Combined digital and bar graph display

Demand:

- Active Energy (kWh)
- Total
- Sub-total

Instantaneous & MAX:

- Voltage (V)
- Current (I)
- Reactive Power (VAr)
- Active Power (W)
- Apparent Power (VA)
- Frequency (Hz)
- Power Factor (PF)
- THD Voltage & Current

Networks:

P1: 1P2W, 1P3W, 3P4W Balanced

P3: 1P2W, 1P3W, 3P3W, 3P3W Balanced, 3P4W, 3P4W Balanced

Inputs/Outputs:

- Pulsed Output
- 2 Digital Outputs
- 4-20mA Analogue Output
- MODBUS® (P3 model only)

Configuration:

- Front Panel Buttons
- USB
- PC Application

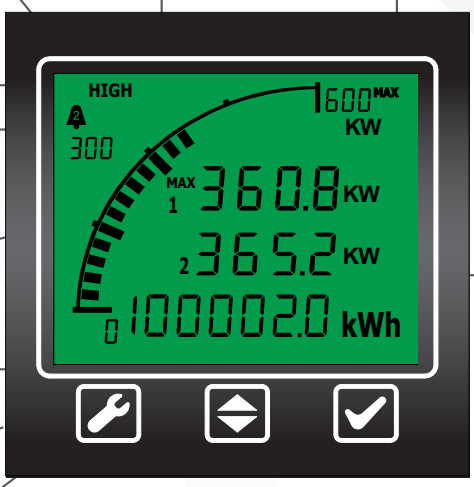

2 user configurable alarms

Programmable scale

2 digital outputs (Alarm or pulsed)
1 Analogue Output
1 MODBUS® (P3 model only)

Less than 75mm deep

Front panel buttons

Programmable star-burst display

CE **RoHS**

Key Features

- **P1** model for single-phase and split-phase; **P3** model for single-, split- and 3-phase applications
- Measures active and reactive power
- Displays electrical parameters on large, backlit LCD display
- Features two independent digital outputs, one analogue 4-20mA output
- **P3** model includes MODBUS® RTU communication
- Provides clear indication of electrical circuit performance
- Digital and bar-graph combo screen simultaneously displays up to 4 electrical parameters
- User-programmable scale and custom annunciators display critical parameters and immediately alert operators when a parameter is out of range

Specifications

P1 POWER METER

P3 POWER METER

NETWORK

1P2W	✓	✓
1P3W	✓	✓
3P3W	✗	✓
3P3W Balanced	✗	✓
3P4W	✗	✓
3P4W Balanced	✓	✓

MEASUREMENT

Voltage Measurement Range	L-L 10 - 600VAC L-N 10 - 300VAC	L-L 10 - 600VAC L-N 10 - 300VAC
Current Measurement Range	0 - 1000A via 5A CT	0 - 1000A via 5A CT
Accuracy	1% (THD 5 %)	1% (THD 5 %)
Display modes	Instantaneous or maximum	Instantaneous or maximum

ENVIRONMENTAL

Temperature - operating	-10 to +60°C	-10 to +60°C
Temperature - storage	-40 to +70°C	-40 to +70°C
IP rating (from the front)	IP65, NEMA type 4 and NEMA type 12	IP65, NEMA type 4 and NEMA type 12

POWER SUPPLY

Input	90-264 VAC	90-264 VAC
Supply frequency	50-60Hz	50-60Hz
Max power	3W	3W

DISPLAY

User Configurable Backlight Colours	Red, Green, White	Red, Green, White
-------------------------------------	-------------------	-------------------

DIGITAL OUTPUTS

Number	2	2
Type	Open Collector	Open Collector
Operating modes	Momentary, Latched or pulsed	Momentary, Latched or pulsed
Max voltage	24VDC	24VDC
Max sink current	15mA	15mA

ANALOGUE OUTPUTS

Number	1	1
Analogue output	4-20mA	4-20mA

COMMUNICATION

MODBUS® RTU	✗	✓
-------------	---	---

CERTIFICATION

	CE, RoHS	CE, RoHS
--	----------	----------

MECHANICAL

Dimensions	72mm x 72mm x 74mm [2.83" x 2.83" x 2.90"]
Cutout	68mm x 68mm [2.68" x 2.63"]
Connection Type	Screw Terminals
Wire Gauge	0.8mm ² - 3.3mm ² (18AWG to 12AWG)
Weight	205 grams

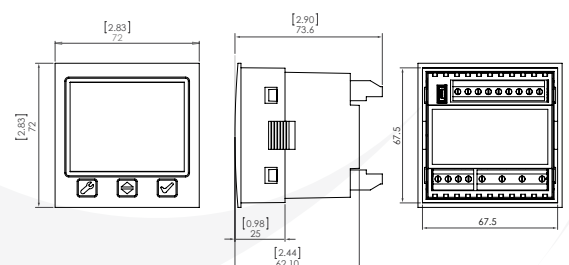

Wiring Diagrams and Isolation

Single phase 2-wire (1P2W)

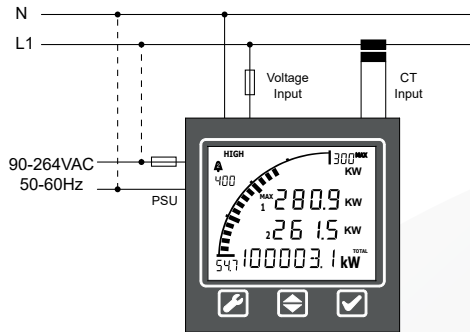

3 phase 3-wire (3P3W) (P3 Model only)

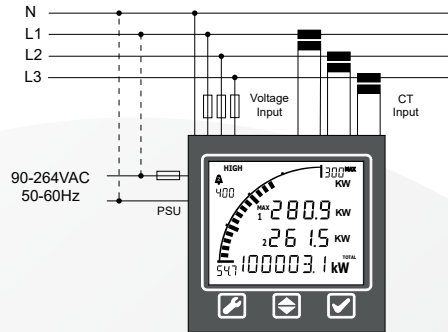

Control outputs & inputs

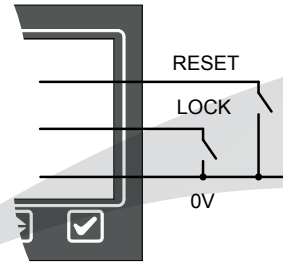
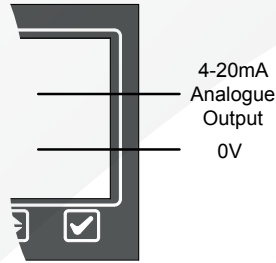
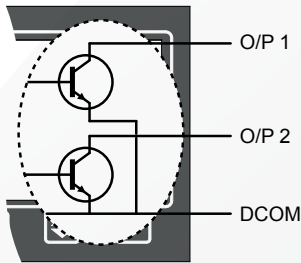

Isolation

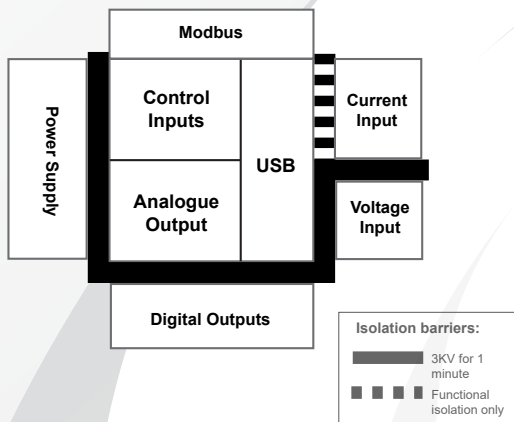

PC Application

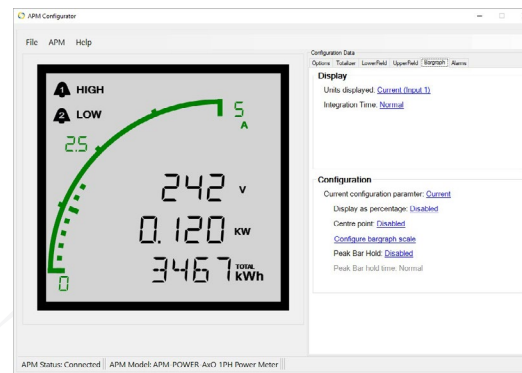

Part Numbers

APM-P1-APO
APM-P3-APO

APM P1 Power Meter, Postive LCD
APM P3 Power Meter, Postive LCD

Full specifications available online www.trumeter.com/apm

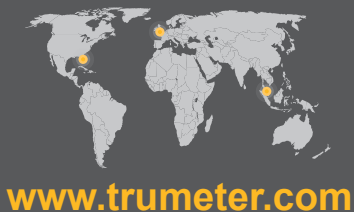

Trumeter (The Americas)
702 S. Military Trail
Deerfield Beach, Florida
FL 33442,
USA
Tel: +1 954 725 6699
Email: sales.usa@trumeter.com

Trumeter (Europe)
Pilot Mill
Alfred Street
Bury,
BL9 9EF
Tel: +44 161 674 0960
Email: sales.uk@trumeter.com

Innovative Design Technologies Sdn. Bhd
Lot 5881, Lorong Iks Bukit Minyak 1
Taman Perindustrian Iks, 14000 Bukit Tengah
Penang, Malaysia
Web: www.idtworld.com
Tel: + 604 5015700
Email: sales.my@idtworld.com